

Rainbow Owner's Manual

800-523-0510

www.rainvac.com

The
Rainbow[®]
CLEANING SYSTEM

is manufactured by

Rexair, Inc.

Troy, Michigan



TABLE OF CONTENTS

Message from the Manufacturer	3
Parts Identification	4
Important Safeguards	6
Wet Pick-up Instructions	7
Proper Care of the Rainbow	7
Care and Cleaning of the Rainbow Hose	7
Operation of the Rainbow	8
Dusting Brush	10
Upholstery Tool	10
Additional Uses for the Rainbow Cleaner	12
Floor and Wall Brush	12
Crevice Tool	12
Sprayer Jar	13
Deodorizing and Aromatizing Instructions	13
Special Equipment and Supplies	14
Operation Checklist	16

D4C



AS
ADVERTISED IN
**Better
Homes
and Gardens®**

D4B



Consumer Care Number

As part of Rexair's Consumer Care program, all new Rainbows receive a Consumer Care Serial Number after passing Quality Control testing at the factory. This serial number assists in providing:

1. Ownership identification for you;
2. Warranty identification for your Distributor;
3. Assurance of having cleared quality control;
4. Assurance of new "factory-fresh" condition.

For your protection, check to see that the serial number is on the Rainbow at the location shown on the accompanying diagram. No new Rainbow should be sold without this number. If the number is missing, Rexair makes no claim as to the origin, age, or condition of the unit. If you can not find a serial number on your Rainbow, please call our customer service department at (313) 879-2600.

For your protection record the serial number in the space provided below. Save this information for future reference.

Serial No. _____

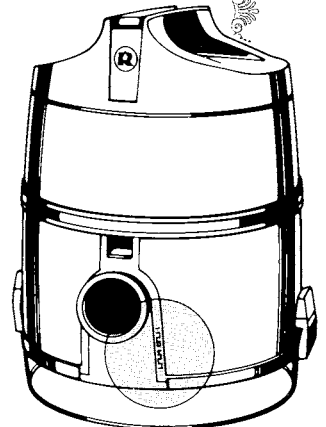

MESSAGE FROM THE MANUFACTURER

REXAIR,® Inc., manufactures the Rainbow® Cleaner for sales only to independent businesspersons, who are experienced in direct in-the-home selling. Since Rexair, Inc., does not attempt to create a market for its product through national advertising, demand for the product is created by the individual efforts of thousands of direct sellers, who, by means of in-home demonstrations, create interest in, and desire for, the Rainbow Cleaner in their local communities. These wholly independent businesspersons assume the responsibility for the legitimate distribution and service of the Rainbow Cleaner directly through their employees and agents, or indirectly through their independent customer resellers, to the ultimate consumer.

Do not lose or mislay the name and address of the independent dealer or distributor from whom you bought the Rainbow Cleaner. Look to him or her for advice on service and the nearest service outlet.

Even though we, the manufacturer neither deal directly with you, the consumer, nor provide a written warranty, the law imposes certain responsibilities on all manufacturers who make consumer products. The products must be generally fit for their intended uses, and be free of defects. These implied warranties of merchantability and fitness run with the product, as provided by the law of your state.

Rexair is selective as to those it appoints as its direct customers, the Registered Distributors. However, Rexair has no agreement or legal relationship with the independent resellers who may acquire products directly or indirectly from a Registered Distributor, and can only attempt to correct any customer complaints about such resellers through pressures imposed on each Registered Distributor.

Furthermore, any Registered Distributor who sells Rainbows to irresponsible independent resellers, who have no concern for consumer protection and deceptive practice laws, will be injuring both the buying public and the goodwill and name of Rexair and the Rainbow vacuum cleaner. Since such customer abuses cannot be permitted, Rexair's announced policy is to hold each Registered Distributor responsible for the cost of remedying the results of any statement or action of any of that Registered Distributor's independent resellers that result in injury to, or abuse of, any member of the ultimate buying public.

Rexair further requires that each Registered Distributor make prompt and workmanlike service available through its own responsible service outlets or through responsible independent service outlets in communities in which it elects to sell directly or indirectly through its independent resellers to ultimate consumer users. These service facilities must be maintained wherever such sales have been made, even if the Registered Distributor or its independent resellers have discontinued their sales efforts in such communities.

Should you have any problems or question regarding the above, you should first contact the distributor or dealer from whom you purchased your Rainbow. If you have any problem locating that person, contact us at the address listed below, being sure that you include your Rainbow's Serial Number. We will immediately send you the name, address and phone number of the responsible Registered Distributor. If you feel that you cannot obtain satisfaction from that Registered Distributor, please contact us immediately. All of our Registered Distributors know of their responsibility.

For any additional information or assistance write to:

Rexair, Inc. • 900 Tower Drive • Suite 700 • P.O. Box 3610 • Troy, Michigan USA 48007 • (313) 879-2600



800-523-0510

www.rainvac.com

PARTS IDENTIFICATION

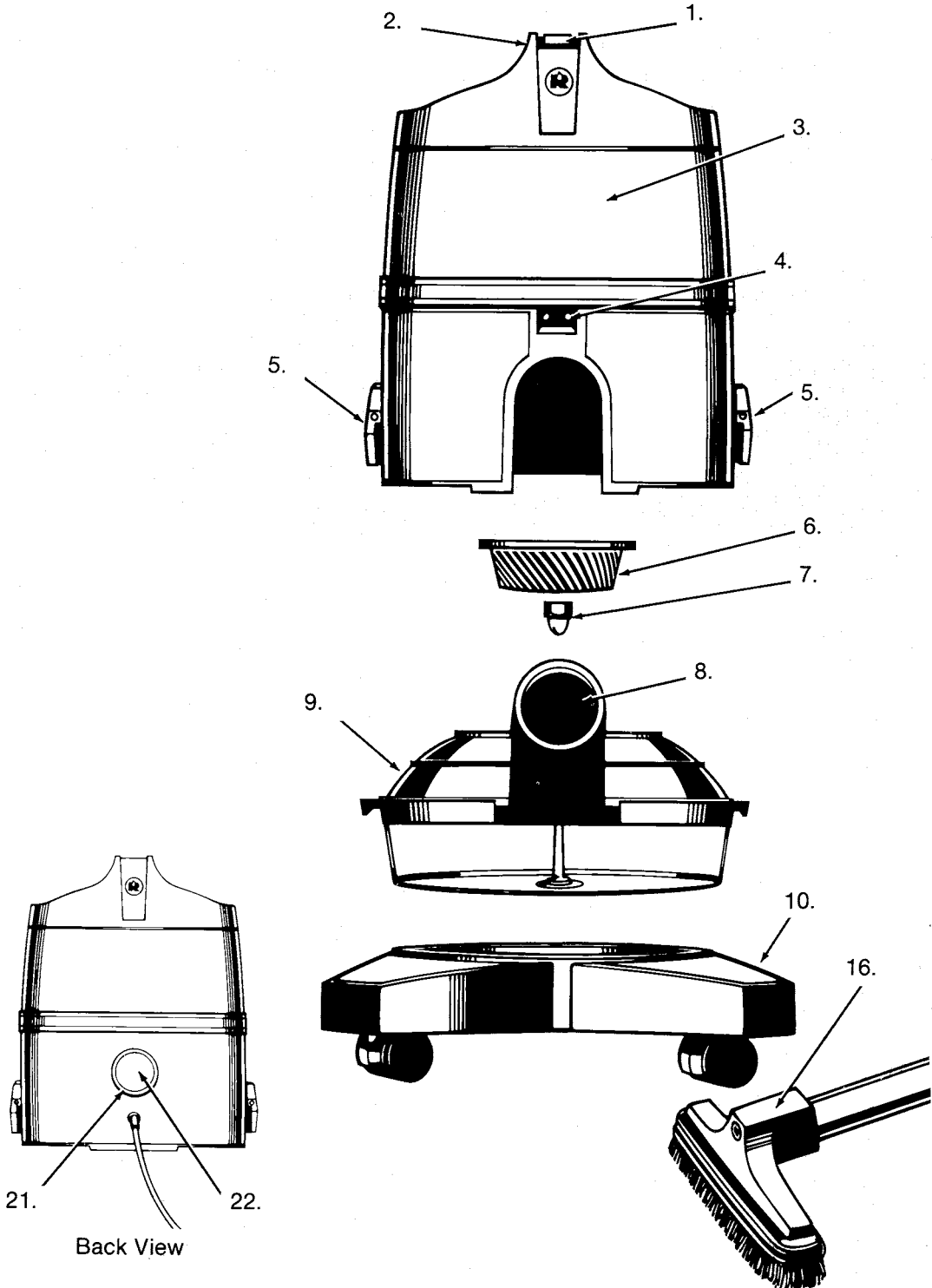

- | | |
|-------------------------------|--------------------------|
| 1. Power Switch | 16. Floor and Wall Brush |
| 2. Handle | 17. Dusting Brush |
| 3. Power Unit | 18. Upholstery Tool |
| 4. Power Nozzle Receptacle | 19. Crevice Tool |
| 5. Water Basin Latches | 20. Sprayer Assembly |
| 6. Separator | 21. Air Exhaust |
| 7. Separator Attaching Nut | 22. Exhaust Cap |
| 8. Air Intake | |
| 9. Water Basin | |
| 10. Dolly | |
| 11. Hose | |
| 12. Curved Wand/Handle | |
| 13. Airflow Control Sleeve | |
| 14. Straight Wand | |
| 15. Floor and Wall Brush Wand | |

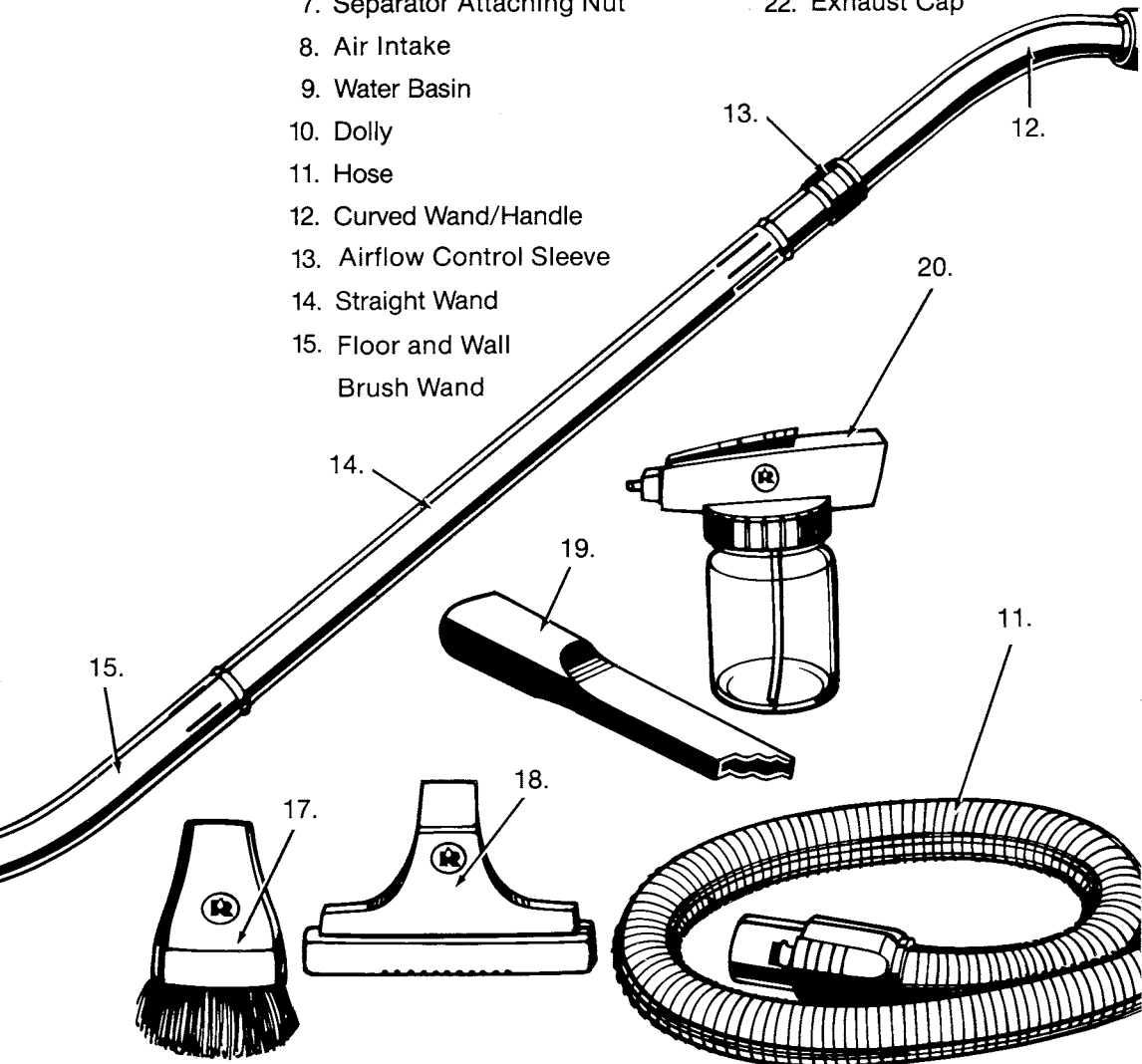

IMPORTANT SAFEGUARDS

1. Please read all instructions carefully. Use your Rainbow only for its intended use as described in the instructions. The use of attachments not recommended by Rexair may cause hazards.
2. Make sure your home electrical system is properly grounded, whether your home is wired for two prongs or three.
3. Close supervision is necessary when any appliance is used by or near children. Do not allow your Rainbow to be used as a toy or to run unsupervised at any time.
4. Unplug the Rainbow when not in use. Turn it off at the switch before unplugging. Grasp the plug to disconnect it from the wall outlet to avoid damage to cord, plug, prongs, or receptacle.
5. Always disconnect cord from electrical outlet before servicing the Rainbow.
6. If Rainbow is in disrepair, do not attempt to operate.
7. Do not clean the unit, or unclog the hose until the plug has been removed from the wall outlet.
8. Do not operate out of an incandescent light fixture, or use any extension cords. Only plug the Rainbow cord into wall outlets that are properly grounded.
9. Do not use the Rainbow to unplug drains. If sewer gas is drawn into the Rainbow it could cause an explosion.
10. No one should ever touch a metal sink, cold or hot water pipe with one hand while touching the metal parts of any electrical appliance, light fixture or switch with the other hand. One's body could complete an electrical circuit to the ground. Additionally, wet skin surfaces can greatly increase this hazard.
11. Always follow these IMPORTANT SAFEGUARDS.
12. CAUTION - ALWAYS REPLACE THE SEPARATOR IMMEDIATELY AFTER CLEANING. DO NOT OPERATE WITHOUT THE SEPARATOR.

WARNING: TO AVOID ELECTRICAL SHOCK
DO NOT USE OUTDOORS.

CAUTION: Do not use the Rainbow to clean the fireplace or the chimney flue, or any other oily or greasy compounds (such as soot) or ashes, ceramic dust or other powdery substances that are impervious to the wetting action of water. Do not use the Rainbow to pick up any volatile or toxic materials.

**USE THE RAINBOW ONLY AS DIRECTED IN
THIS OPERATION MANUAL!**



WET PICK-UP INSTRUCTIONS

When using the Rainbow for wet pick-up follow directions exactly:

1. Start with empty basin and never pick up more than two quarts without emptying. That is to say, NEVER let water level in basin get above center post. This will cause the Rainbow to vibrate or shake.
2. Do not use when your hands are wet, or with bare or wet feet.
3. Do not stand in water when using the Rainbow for wet pick-up. However, if in order to pick up water you find it necessary to stand on a wet (damp) floor, be absolutely certain you do not touch the metal parts of any electrical appliance, light fixture or switch.
4. Never use for wet pick-up outside, on the ground, in a basement, or in a room where a film of water can reach a ground.
5. Do not touch any metal parts of the Rainbow motor unit, such as the separator attaching nut, until you have first disconnected the electrical cord from the wall outlet.

PROPER CARE FOR LONG LIFE OF THE RAINBOW

SEPARATOR - Clean the separator frequently. We recommend that this be done weekly. Remove separator with a screw driver, clean inside and out with soap and water using the Rainbow Separator Brush, which is supplied. Dry and replace the separator. Tighten the nut easily to hold the flat rim of the separator snug. Do not force the separator nut so it depresses the separator into the shaft onto which the nut is threaded.

**CAUTION-ALWAYS REPLACE THE SEPARATOR IMMEDIATELY AFTER CLEANING.
DO NOT OPERATE WITHOUT THE SEPARATOR.**

WATER - Do not clean too long with one filling of water. Check water during cleaning, and if water is too thick with lint and dirt, empty dirty water and put in clean water. The correct water level is the top of the post located in the center of the Rainbow® water basin. NEVER FILL BASIN ABOVE POST.

BASIN - After each cleaning the basin should be emptied, washed out thoroughly and dried. Leave the Rainbow OFF basin while storing between each cleaning. DO NOT PUT THE RAINBOW AWAY WITH EITHER WATER OR DIRT IN BASIN.

Neglecting part or all of the above instructions will cause unnecessary trouble and expense for service. Following these instructions should give you years of trouble-free, efficient service.

THE RAINBOW® HOSE

The nylon reinforced hose is light in weight and truly flexible. The handle at the end is easy on the hands, and assures a firm hold of the hose at all times. To clean: insert hard coupling marked "PRESS" into exhaust opening after removing exhaust cap. Place the soft end of the hose into the air intake. Switch on motor and jiggle hose. Any dirt stuck in the hose will be drowned in the Rainbow's water bath.

OPERATION AND CARE

1 Fill water basin with cold tap water up to the top of the post located in the center of the basin. This is the correct amount of water (2 quarts) for all cleaning operations performed by the Rainbow.

2 Set power unit on top of basin so air intake protrudes through side opening. **Be sure that entire rim of power unit is firmly seated in groove on top of basin.** Hook the two clamps to the rim of the water basin and snap up. Place on dolly.

3 Insert the long curved bottom wand into the floor and wall brush by matching grooves on tool with bumps on wand. Give tool half a turn to lock in place.

Reminder: The water in the basin must remain liquid to effectively trap dust and dirt. Therefore, **DO NOT** clean too long with one filling of water. When water becomes thick with lint and dirt, empty water basin and refill.

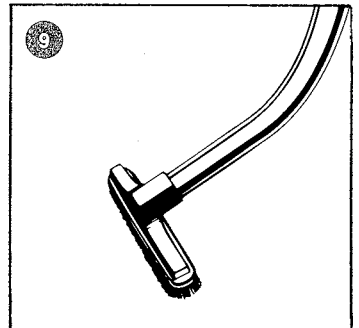
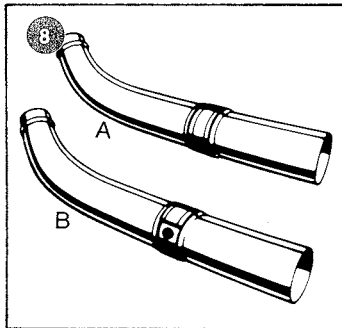
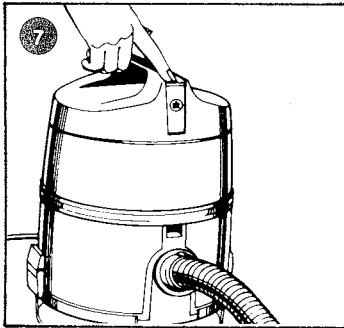
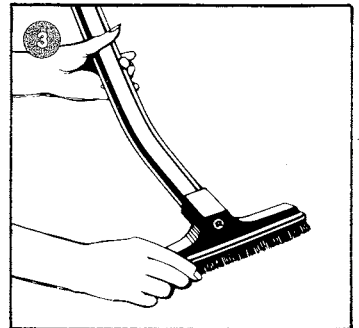
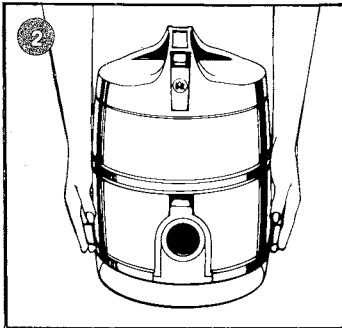
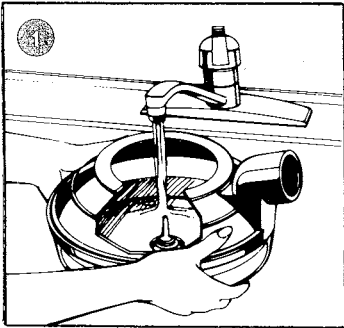

7 Connect electrical cord to outlet. Turn switch on top handle to the "ON" position.

8 A) Adjust airflow control sleeve on top of handle. Close opening with airflow control sleeve for full power.

B) To reduce airflow, rotate airflow control sleeve so opening in handle is exposed. Adjust as needed for different cleaning jobs.

9 With the machine at the left and to the rear, hold the handle with the right hand at a comfortable angle. Grasp the hose with the left hand making a loop behind the back. Slowly guide the tool back and forth in smooth and easy strokes. Let the tool and the Rainbow do the work.

Warning: Because of the danger of shock, any electrical appliance should be used only as directed. There should be no unapproved use of any electrical product. Electrical leakage and shorts can occur wherever there is electricity. With any electrical appliance, if the user is not grounded there is generally no serious hazard. But if the user is standing on the ground, in a basement, or in a room where a film of water can reach a ground, severe shock could result. Therefore, use the Rainbow only as directed in this operation manual. **Refer to the Important Safeguards Section on page 6.** This, of course, is true of any use of electricity with electrical fixtures or appliances that can develop shorts.

4) Connect the straight wand and handle (short curved wand) and insert into the bottom wand with tool on end. Should the wands come apart while in use, tap lightly with curved wand, between slots at end of the bottom wand and/or straight wand until a snug fit is obtained. Should wands wedge tightly together, hold parallel to the rug or carpet and drop them. The vibration will cause them to loosen. Repeat the process if necessary. If the wands are properly adjusted for snugness they will not wedge together.

5) Push soft end of hose over raised ridge on handle until it "SNAPS" in place.

6) Insert metal end of hose into the air intake until it clicks. To remove, press spot on coupling marked "PRESS" and pull hose from machine.

DOUBLE INSULATED—
WHEN SERVICING,
USE ONLY IDENTICAL
REPLACEMENT PARTS

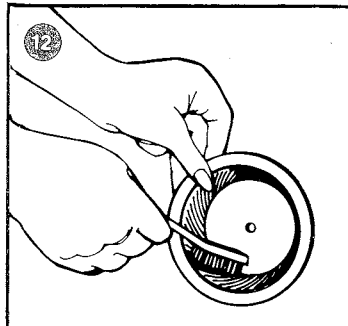
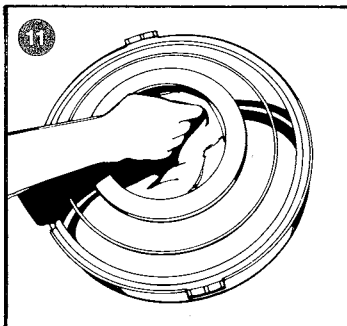
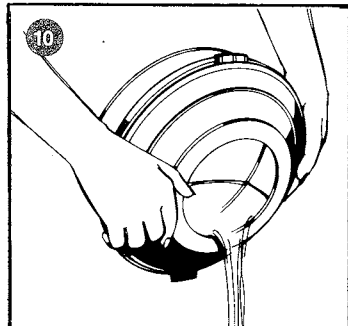
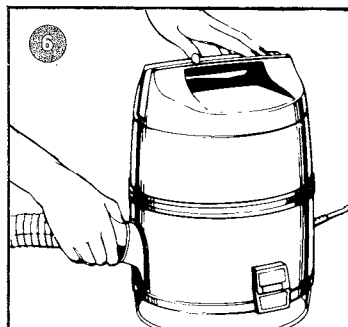
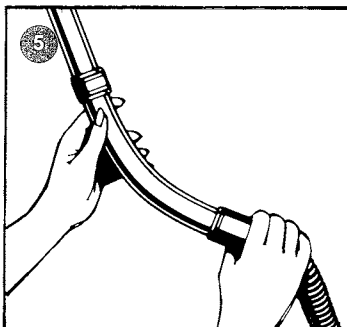
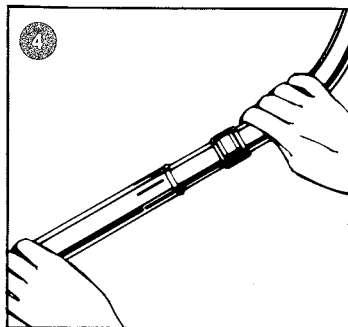

10) To empty water basin: 1) release the two clamps. 2) Remove power unit. 3) Pick up water basin by the curved air intake and pour dirty water from the opposite side into an acceptable drain. 4) The heavier particles of foreign matter, such as soaked lint, etc. will settle to the bottom of the basin when pouring out the dirty water. 5) Next, it is recommended that you simply remove the wet, foreign matter, such as soaked lint, etc., by placing it into a plastic disposal bag or waste container instead of disposing of it into the commode or drainage system.

11) Wash out water basin, rinse and dry thoroughly. Leave Rainbow power unit OFF basin until the next time it is used. **DO NOT STORE RAINBOW WITH WATER OR DIRT IN THE BASIN.**

12) **SEPARATOR**—Clean the separator frequently. We recommend cleaning after each use. Remove separator with a screw driver, clean inside and out with soap and water using the Rainbow separator brush, which is supplied. Dry and replace the separator. Tighten the nut easily to hold the flat rim of the separator snug. Do not force the separator nut so it depresses the separator into the shaft onto which the nut is threaded. **CAUTION—ALWAYS REPLACE THE SEPARATOR IMMEDIATELY AFTER CLEANING. DO NOT OPERATE WITHOUT THE SEPARATOR.**

DUSTING BRUSH AND UPHOLSTERY TOOL

1 The soft, all-natural bristles of the Rainbow® dusting brush will not harm even the finest furniture, fixtures, or fabrics. Just attach the dusting brush to the curved wand handle and move the brush lightly over the surface to be cleaned.

2 The dusting brush is also perfect for previously hard to clean surfaces like louvered blinds.

3 Use it for cleaning dogs and cats. Dust, dirt and loose hair are easily removed by the Rainbow's silent airflow. Frequent grooming cuts down on the need for baths and your pet will enjoy it too.

Reminder: Don't forget - for use on delicate objects, reduce airflow by opening the Airflow Control Sleeve. To clean the dusting brush, whisk open end of hose over bristles. For a more thorough cleaning to remove greasy lint and dirt, pull brush from tool and wash with warm, soapy water.

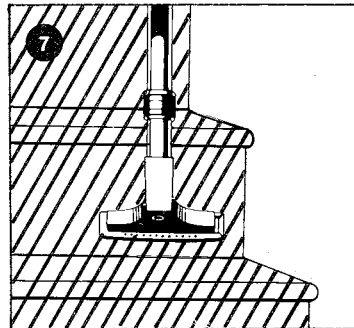
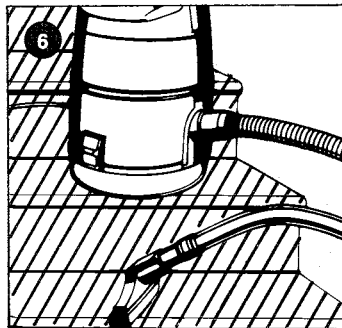
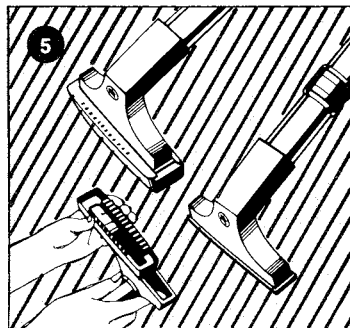
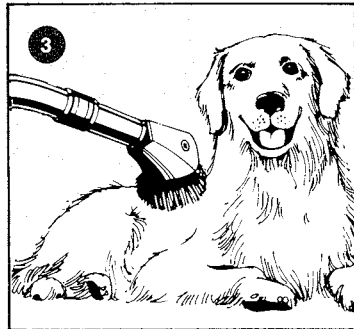
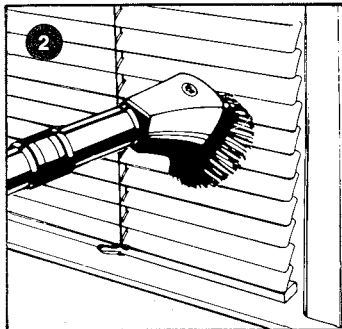
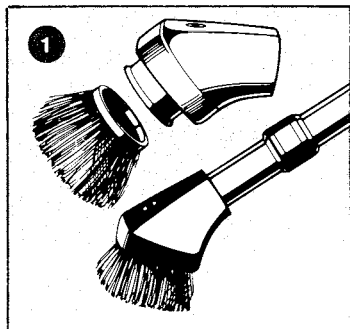

5 To clean upholstered furniture use the Rainbow® upholstery tool. The upholstery tool may be used alone or with the Jet Brush (see above illustration). Attach upholstery tool to curved wand handle. A slight twist as they are pushed together will make them hold securely. Use with full airflow. To remove dirt, move tool over areas to be cleaned with slow, even strokes. To clean Jet Brush, whisk with open end of hose or slide upholstery tool out of the slots on top of the brush and wash in warm soapy water.

6 To clean stairs, remove Rainbow from dolly. Allow the Rainbow to rest solidly on stair above the one being cleaned. Move the Rainbow up one step at a time and continue cleaning.

7 To clean rug riser, turn tool one-half turn and use as illustrated.

4 Reduce airflow and gently brush over plants to remove dust and dirt which blocks light and hides the natural sheen of the foliage.

Try your Rainbow® dusting brush on: • lighting fixtures • lamp shades • stereo and VCR equipment • picture frames • pianos • hats • heat and cold air vents • inside kitchen and bathroom drawers • screens.

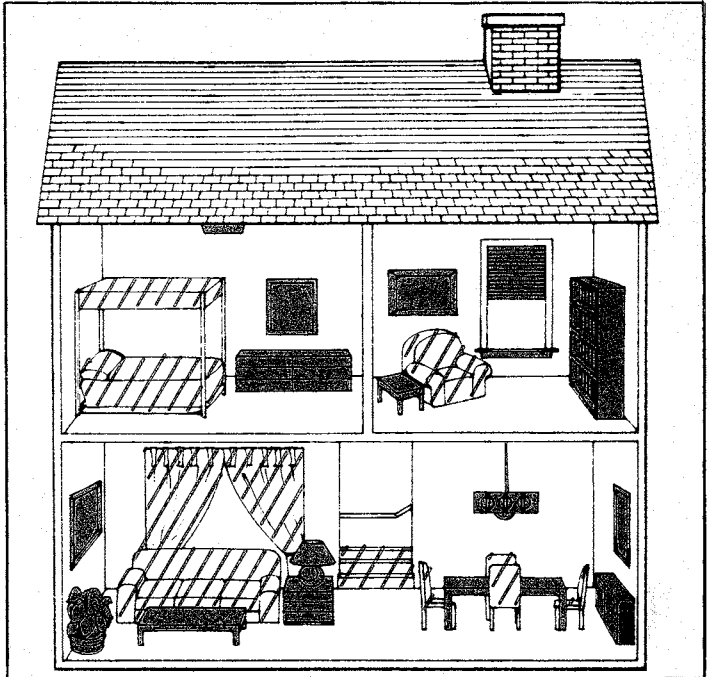
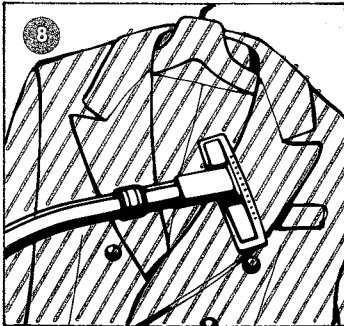
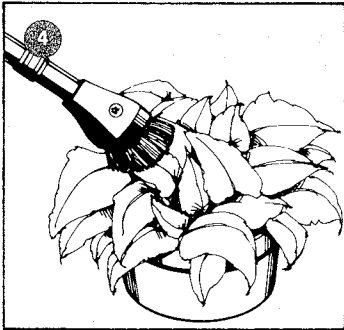

8 Clean the surface of suits, wool and fur coats, with upholstery tool with the jet brush. For delicate fabrics, reduce airflow.

Use the upholstery tool with jet brush on: • sofas • chairs • mattresses • pillows • blankets • drapes and curtains • closet shelves • Help prevent moths by cleaning wool coats and sweaters before storing.

ADDITIONAL USES FOR THE RAINBOW

 To clean hardwood floors, linoleum, tile, or walls, use the combination floor and wall brush. Attach the brush to the metal wand. The brush locks into position and will not fall off. Use full airflow when cleaning floors.

1A) When cleaning walls, best results are obtained when only the top edge of the brush is allowed to touch the wall and cleaning is done with a downward stroke. With a slight space between the wall and the bottom edge of the brush, dust is removed before the bristles touch it, thus avoiding streaks.

1B) To clean the floor and wall brush, just whisk it clean with the open end of the hose, or remove furniture guard and snap off brush from holder. Wash brush in warm soapy water and reassemble when dry. Beaded edge of guard should be up.

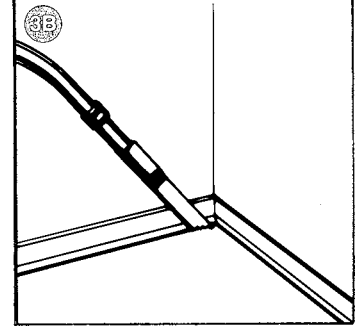
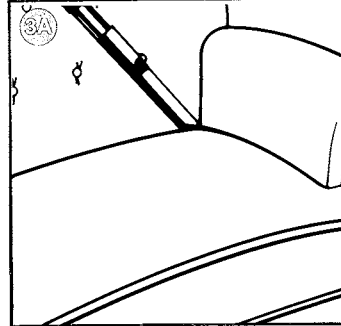
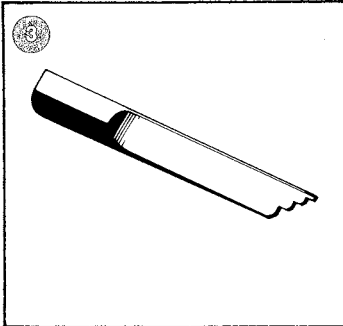
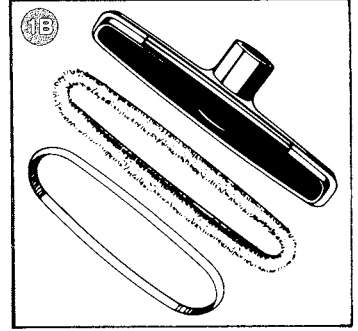
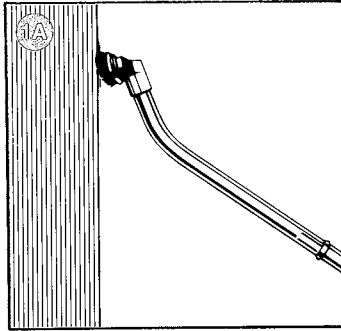
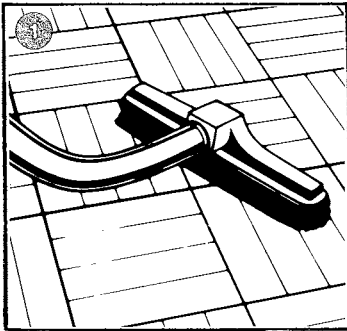

 The Rainbow® crevice tool is designed to achieve maximum airflow and cleaning power. Attach to curved wand and use full airflow, with airflow control sleeve closed.

3A) Use crevice tool to clean deep down between furniture and automobile cushions.

3B) The crevice tool reaches those low areas along baseboards, under radiators, and between radiator sections.

CLEANER



2 TO USE THE RAINBOW® SPRAYER... Fill glass sprayer jar 3/4 full of solution to be used. Screw on sprayer cap and attach to handle (short curved wand) with a twisting motion so sprayer is held firmly in place. Close airflow control sleeve for full power. Attach handle to hose, remove exhaust cap and attach hose to air exhaust opening on the Rainbow.

2A) Use thumb to push plunger down... sprayer tip should be tight at all times. Release of plunger automatically stops spray. It is not necessary to turn Rainbow on and off. When spraying job is completed, clean jar. Add water or solvent (depending upon material sprayed) and spray through sprayer. Clean tip. Do not allow particles to remain in jar, sprayer or in tip.

2B) TO SPRAY INSECTICIDES, MOTH PROOFING SOLUTIONS and OTHER LIQUIDS... Follow directions for using sprayer attachment. Adjust sprayer to volume desired for use and solution. When spraying in closets adjust to lowest volume. With the Rainbow sprayer pinpoint adjustment plunger, it is easy to spray most liquids with accuracy and uniformity.

Caution: Be sure to follow manufacturers instructions when using chemical solutions.

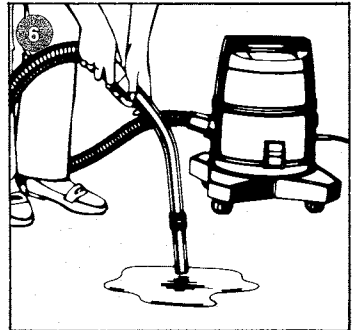
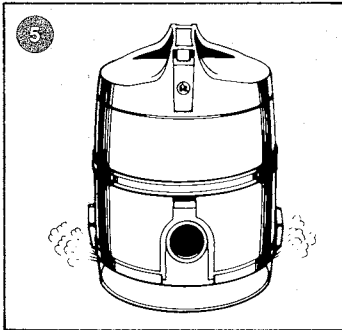
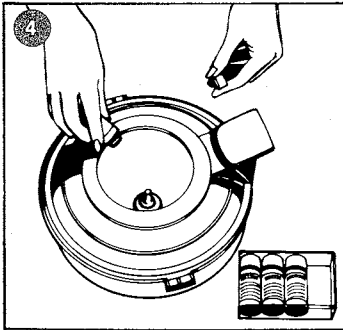
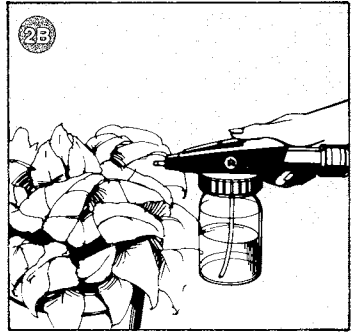
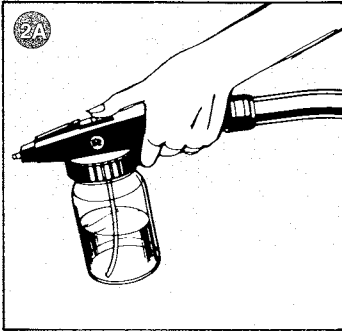
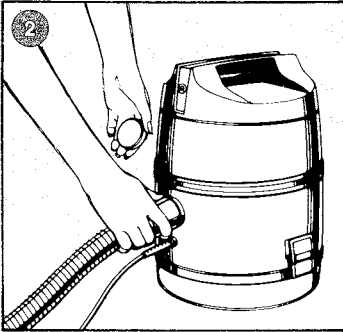

4 TO AROMATIZE... Put a few drops of any Rainbow® fragrance such as Violet, Apple Blossom, Siberian Pine, or Gardenia in the Rainbow water basin. Assemble the Rainbow on the basin and turn on switch. In a matter of minutes a pleasant fragrance will permeate the room.

5 TO DEODORIZE... Add two capfuls of Rainbow® Deodorant Air Freshener to the water in the basin, turn machine on. The 360 degree peripheral exhaust quickly refreshes the air in the entire area, alleviates objectionable household odors.

6 TO USE YOUR RAINBOW FOR WET PICK-UP... Refer to wet pick-up instructions on page 7. Follow these instructions carefully and NEVER LET WATER LEVEL GET HIGHER THAN CENTER POST IN WATER BASIN.

Caution: Use only genuine Rainbow Fragrances. The use of non-approved fragrances may cause damage to your Rainbow.

SPECIAL EQUIPMENT & SUPPLIES

1 4-Quart Basin

The Rainbow® 4-Quart Basin is available for those "bigger" cleaning jobs. The larger water basin fits the Rainbow dolly and doubles the cleaning capacity of the Rainbow. It's ideal for larger homes and "over-sized" cleaning jobs.

2 Floor Squeegee

The new Rainbow® Floor Squeegee allows you to deep-clean your linoleum and tile floors without getting your hands wet. Use with Rainbow® Floor Cleaner Concentrate to clean your floors with a minimum of effort.

3 Attachment Caddy

The Attachment Caddy snaps into place on your Rainbow and provides convenient storage for your Rainbow attachments and power cord.

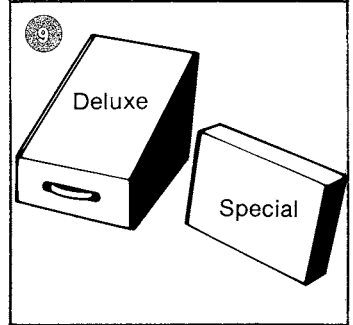
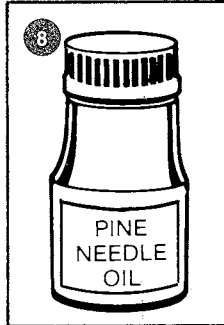
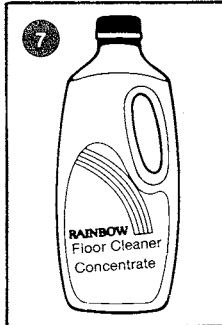
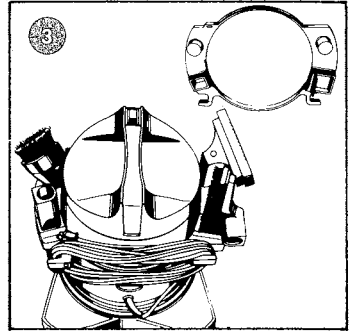
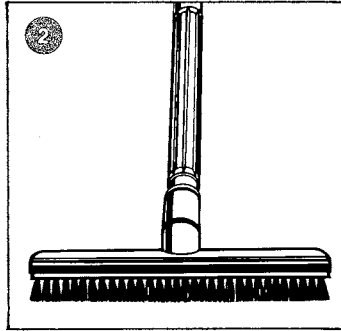
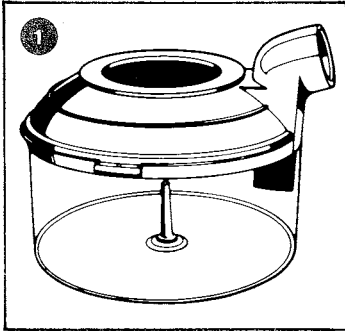

6 Rainbow® Deodorizer-Air Freshener

Two capfuls of Rainbow Deodorizer-Air Freshener added to the water in the Rainbow Water Basin alleviates objectionable household odors such as fish, tobacco, cabbage, paint, etc. One quart.

7 Rainbow® Floor Cleaner Concentrate

Rainbow Floor Cleaner Concentrate is ideal for thoroughly cleaning linoleum or tile floors. Just spread on Floor Cleaner Concentrate in recommended solution and let it do the work. One quart.

9 Rainbow® Accessory Packs

A) Deluxe Accessory Pack includes the following items: 1) 4-Quart Basin, 2) Floor Squeegee, 3) Attachment Caddy, 4) Fragrance Pack, 5) Aerofresh Bag, 6) Deodorizer-Air Freshener and, 7) Floor Cleaner Concentrate.

5 Rainbow® Pine Needle Oil

Rainbow Pine Needle Oil adds a delightful Pine Needle freshness to the home. Simply break only one capsule into the water in the Rainbow Water Basin and bring the fragrance of pine indoors. 100 capsules.

B) Special Accessory Pack includes: 3) Attachment Caddy, 4) Fragrance Pack, 5) Aerofresh Bag and, 6) Deodorizer-Air Freshener.

4) Rainbow® Fragrance Pack
 Bring the sweet and refreshing smell of a spring garden into your home with the Rainbow Fragrance Pack. Apple Blossom, Violet, Gardenia and Siberian Pine Fragrance will fill your home with the pleasant aroma of the great outdoors.

5) Aerofresh Bag
 This handy plastic bag is sized to fit even your largest cushions and pillows. Helps remove stale, dusty air and replace it with water-washed fresh air.

CONTACT YOUR LOCAL REGISTERED RAINBOW DISTRIBUTOR FOR INFORMATION ON THESE VALUABLE RAINBOW ACCESSORIES.

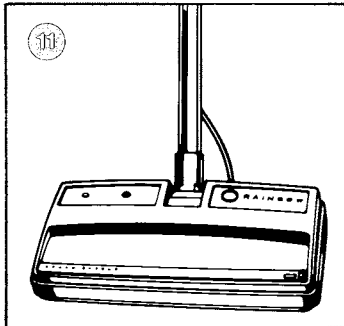
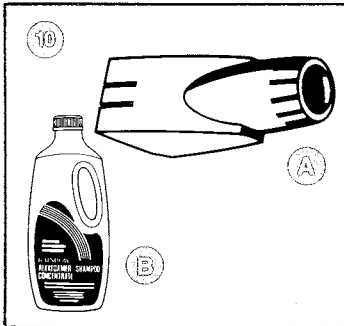
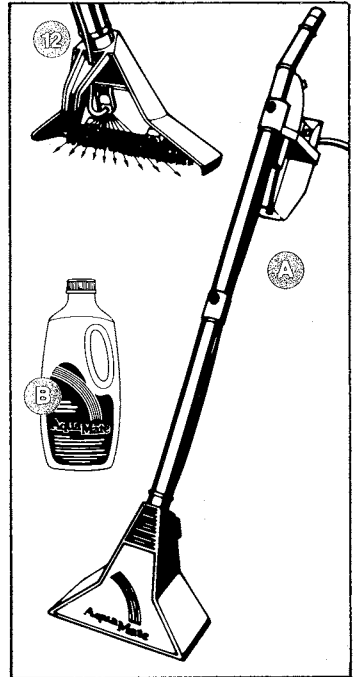
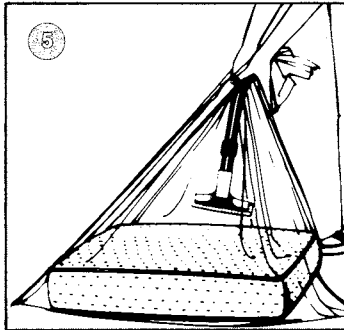

10) Rexafoamer
 A) The Rainbow® Rexafoamer makes "dry" suds from liquid shampoos. Your rugs and carpets can be shampooed inexpensively, yet professionally, right in the home.
 B) Rexafoamer Shampoo Concentrate quickly removes unsightly traffic film from rugs and carpets. No hard scrubbing required. Cleanses thoroughly, dries quickly. One quart.

11) Rainbow® Power Nozzle
 The Power Nozzle adds motorized beater brush action to the already superlative cleaning efficiency of the Rainbow. The rapidly revolving brush and beater bars loosen lint, threads, hair and dirt for easy pick-up into the Rainbow water basin. It connects quickly and conveniently to the Rainbow and makes most deep nap, pile and shag carpets easier to groom and clean. The fully motorized Power Nozzle is easy to use, sturdy and lightweight.

12) A) AquaMate®
 The AquaMate carpet cleaning extraction unit allows you to achieve professional results without the professional price tag.

B) AquaMate Carpet Cleaning Formula combines cleaner, deodorizer, protector, and reconditioner for ease of operation and superior cleaning results. One quart.

Warning: Severe electrical shock could occur if used outside or on wet surfaces.

OPERATIONS CHECKLIST



This Rainbow appliance was thoroughly tested and inspected at the factory. It was in good operating condition when shipped. If a minor problem develops, the following trouble shooting procedures may help identify and correct the problem with a minimum inconvenience.

PROBLEM	POSSIBLE CAUSE	POSSIBLE SOLUTION
A. Machine Won't Run	<ol style="list-style-type: none"> 1. Not connected at wall outlet 2. No power to wall outlet 3. Defective cord, switch, or machine 	<ol style="list-style-type: none"> 1. Insert plug firmly into wall outlet or try another outlet 2. Check fuse or breaker and replace if bad 3. Call your Rainbow Distributor or Rainbow Service Center
B. Loss of Air Flow	<ol style="list-style-type: none"> 1. Machine not correctly positioned on waterpan 2. Obstructed hose 3. Obstructed wand 4. Obstructed attachment utensil, or Power Nozzle 5. Clogged or dirty separator 	<ol style="list-style-type: none"> 1. Insure machine is correctly seated and latched onto waterpan 2. Remove obstruction 3. Remove obstruction 4. Remove obstruction 5. Turn off and unplug machine. Remove separator and clean
C. Discharges Water or Water Droplets	<ol style="list-style-type: none"> 1. Dirty or clogged separator 2. Separator not correctly seated 	<ol style="list-style-type: none"> 1. Clean separator 2. Clean area under separator and insure separator seats against spider shaped part correctly
D. Discharges Dust	<ol style="list-style-type: none"> 1. Dirty or clogged separator 2. Separator not correctly seated 3. Low level of water in waterpan 4. Excessively dirty water in waterpan 	<ol style="list-style-type: none"> 1. Clean separator 2. Clean area under separator and insure separator seats against spider shaped part correctly 3. Fill waterpan to correct level 4. Replace with clean water
E. Heavy Foaming of Water in Waterpan	<ol style="list-style-type: none"> 1. Soapy contaminant in water 2. High level of water in waterpan 	<ol style="list-style-type: none"> 1. Replace with clean water 2. Fill waterpan to correct level
F. Musty Odor	<ol style="list-style-type: none"> 1. Waterpan not cleaned or dumped after use 2. Separator not cleaned after use 3. Machine stored on waterpan 	<ol style="list-style-type: none"> 1. Clean waterpan 2. Clean separator 3. Use recommended quantity of Rainbow D & A in waterpan
G. Machine Running Hot or Burnt Odor	<ol style="list-style-type: none"> 1. Plugged hose, wand, attachment, or Power Nozzle 2. Machine not seated on waterpan correctly 3. Separator not correctly seated 	<ol style="list-style-type: none"> 1. Check for clogged area and remove obstruction 2. Insure machine is correctly seated and latched onto waterpan 3. Insure separator is correctly seated
H. Different Tone, Noise or Vibration	<ol style="list-style-type: none"> 1. Dirty or clogged separator 2. Separator not correctly seated 3. Water level above center post in waterpan 	<ol style="list-style-type: none"> 1. Clean separator 2. Insure separator is correctly seated 3. Empty and refill to correct level

NOTE: If the above solutions do not prove successful, call your Registered Independent Distributor.