

*Special
Edition*

Rainbow **SE** **owner's Manual**

THE RAINBOW IS MANUFACTURED BY REXAIR AND SOLD TO ITS AUTHORIZED RAINBOW DISTRIBUTORS FOR RESALE SOLELY THROUGH IN-HOME DEMONSTRATIONS TO ULTIMATE USER-OWNERS. ANY OTHER SALE IS STRICTLY PROHIBITED.

Dear **Rainbow** Owner:

Welcome to the evergrowing **Rainbow** Family!

You have made a wise investment by purchasing your **Rainbow** product. Rexair, Inc., the manufacturer of the **Rainbow**, has established a proud heritage of manufacturing a superior product for nearly 60 years. The **Rainbow** product is marketed in every one of the United States and over 40 international countries.

Please feel free to call upon your local **Rainbow** distributor or Rexair, Inc., Troy, Michigan for any assistance.



Consumer Care Number

As part of Rexair's Consumer Care program, all new **Rainbows** receive a Consumer Care Serial Number after passing Quality Control testing at the factory. This serial number assists in providing:

1. Ownership identification for you
2. Warranty identification for your Distributor
3. Assurance of having cleared quality control
4. Assurance of new "factory-fresh" condition

For your protection, check to see that the serial number is on the **Rainbow** at the location shown on the accompanying diagram. No new **Rainbow** should be sold without this number. If the number is missing, Rexair makes no claim as to the origin, age, or condition of the unit. If you can not find a serial number on your **Rainbow**, please call our customer service department at (248) 643-7222, or fax to (248) 643-7676.

For your protection record the serial number in the space provided below. Save this information for future reference.

Serial No. _____

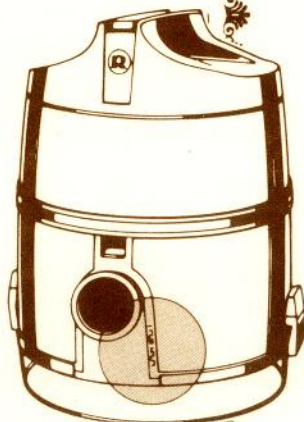

The
Rainbow[®]
CLEANING SYSTEM
is manufactured by
Rexair, Inc.
Troy, Michigan

The configuration of the **Rainbow**[®] Cleaning System and the words **Rainbow**[®], **RainbowMate**[®] and **Rexair**[®] are registered trademarks of Rexair, Inc., Troy, Michigan

TABLE OF CONTENTS

Message from the Manufacturer	3
Parts Identification	4
Important Safeguards	6
Wet Pick-up Instructions	7
Proper Care of the Rainbow	7
Operation of the Rainbow	8
Dusting Brush	10
Upholstery Tool	10
Additional Uses for the Rainbow Cleaner	12
Floor and Wall Brush	12
Crevice Tool	12
Attachment Caddy	13
Deodorizing and Aromatizing Instructions	13
Inflator Tool and Refrigerator Coil Cleaner Extension	14
Care and Cleaning of the Rainbow Hose	14
Special Equipment and Supplies	15
Operations Checklist	Inside Back Cover



Your Authorized Rainbow Distributor

Name: _____

Address: _____

City/State/Zip: _____

Phone: _____

Dealer Signature: _____

MESSAGE FROM THE MANUFACTURER



Rexair, Inc.

REXAIR, INC., manufactures the **Rainbow** Cleaner for sale only to independent Authorized Distributors, who are experienced in direct in-the-home selling. Since Rexair does not market its product through national advertising, awareness of the product is created by the individual efforts of thousands of direct selling "dealers," who, by means of in-home demonstrations create interest in the **Rainbow** Cleaner in their local communities. The independent Authorized Distributors with whom those dealers are affiliated assume the responsibility for the legitimate distribution and service of the **Rainbow** Cleaner directly through their own dealers, or indirectly through independent subdistributors and their dealers.

Rexair provides to its Authorized Distributors, and only to them, a written three year warranty on its products. Even though Rexair, as the manufacturer, does not deal directly with the consumer nor provide the consumer with a written warranty, the law imposes certain responsibilities on all manufacturers who make consumer products. The products must not be defective and must be generally fit for their intended uses. These implied warranties of merchantability and fitness are honored by Rexair. Further, Rexair requires each Authorized Distributor to pass through to the consumer, by way of the Authorized Distributor's own written warranty, the benefit of Rexair's warranty to such Distributor.

Rexair further requires that each Authorized Distributor make prompt and workmanlike service available through its own service outlets or through responsible independent service outlets in those communities in which it sells Rexair products through its independent subdistributors and dealers.

Do not lose the name and address of the dealer or distributor from whom you bought the **Rainbow** Cleaner. Contact him or her for advice on caring for your **Rainbow**, warranty coverage, service, and the nearest service outlet.

Rexair is highly selective regarding those it appoints as its direct customers, the Authorized Distributors. However, Rexair has no agreement or legal relationship with the independent resellers who acquire products directly or indirectly from an Authorized Distributor, and can only attempt to correct any customer complaints about such resellers by acting through the responsible Authorized Distributor. Rexair's announced policy is to hold each Authorized Distributor responsible for remedying the results of any statement or action by any of the independent resellers that may result in a complaint from any member of the buying public.

Should you have any problem, or have any question regarding the above, you should first contact the distributor or dealer from whom you purchased your **Rainbow**. If you have any problem locating that person, contact Rexair's Customer Service Department at the address listed below, being sure that you include your **Rainbow's** Serial Number. They will immediately send you the name, address and phone number of the responsible Authorized Distributor for your area. If you feel that you get no help from the Authorized Distributor, please contact us immediately. All of our Authorized Distributors know their obligations.

For any additional information or assistance write to:

Rexair, Inc., 3221 W. Big Beaver Road, Suite 200, Troy, Michigan 48084, (248) 643-7222 or fax to (248) 643-7676.

**THE RAINBOW IS MANUFACTURED BY REXAIR AND SOLD TO ITS
AUTHORIZED RAINBOW DISTRIBUTORS FOR RESALE SOLELY
THROUGH IN-HOME DEMONSTRATIONS TO ULTIMATE USER-OWNERS.
ANY OTHER SALE IS STRICTLY PROHIBITED.**

PARTS IDENTIFICATION

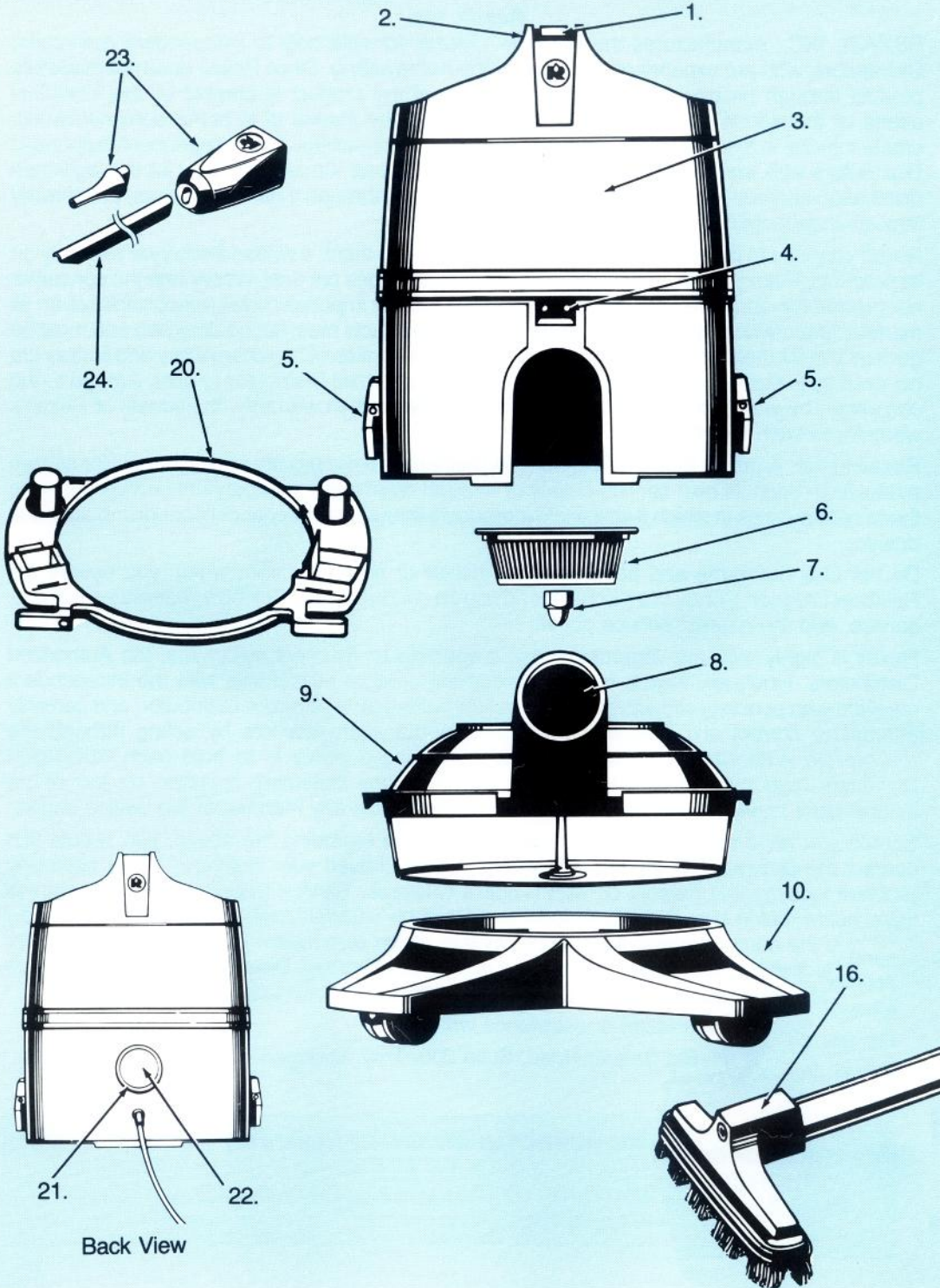

Back View

- | | |
|----------------------------------|--------------------------|
| 1. Power Switch | 16. Floor and Wall Brush |
| 2. Handle | 17. Dusting Brush |
| 3. Power Unit | 18. Upholstery Tool |
| 4. Power Nozzle Receptacle | 19. Crevice Tool |
| 5. Water Basin Latches | 20. Attachment Caddy |
| 6. Separator | 21. Air Exhaust |
| 7. Separator Attaching Nut | 22. Exhaust Cap |
| 8. Air Intake | 23. Inflator Tool |
| 9. Water Basin | 24. Refrigerator Coil |
| 10. Dolly | Cleaner Extension |
| 11. Rainbow Hose | |
| 12. Curved Wand/Handle | |
| 13. Airflow Control Sleeve | |
| 14. Straight Wand | |
| 15. Floor and Wall
Brush Wand | |

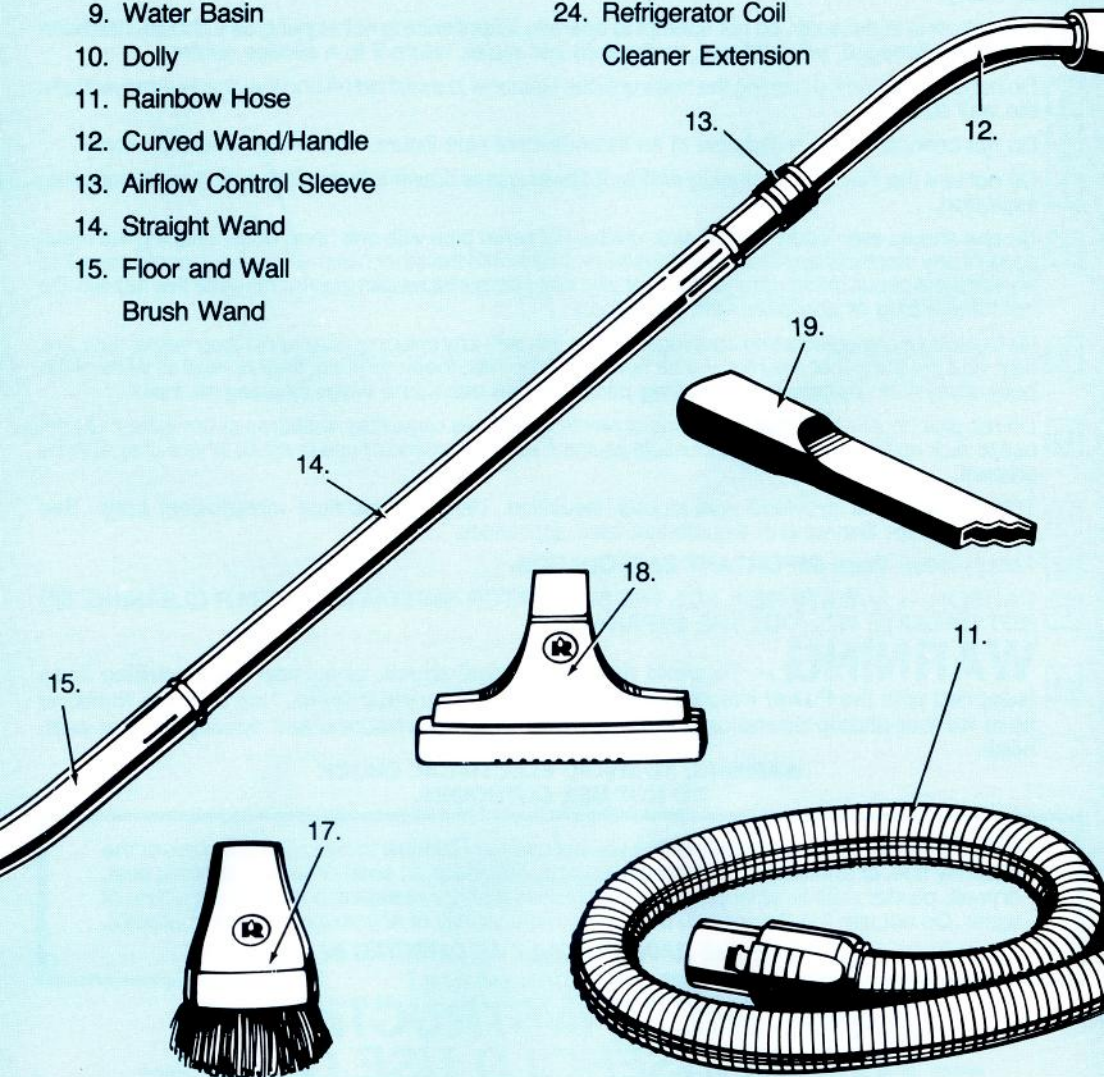

IMPORTANT SAFEGUARDS

Please read all instructions carefully before using unit. Use your Rainbow only for its intended use as described in the instructions. The use of attachments not recommended by Rexair may cause hazards.

WARNING — to reduce the risk of fire, electric shock, or injury, when using an electrical appliance, basic precautions should always be followed, including the following:

- 1 Close supervision is necessary when any appliance is used by or near children. Do not allow your Rainbow to be used as a toy or to run unsupervised at any time.
- 2 Unplug the Rainbow when not in use. Turn it off at the switch before unplugging. Grasp the plug to disconnect it from the wall outlet to avoid damage to cord, plug, prongs, or receptacle. Do not pull or carry by cord, use cord as a handle, close a door on cord, pull or carry around sharp edges or corners. Do not run appliance over cord. Keep cord away from heated surfaces. Do not use with damaged cord or plug.
- 3 Do not leave appliance when plugged in. Unplug Rainbow from outlet when not attended and before servicing.
- 4 If Rainbow is in disrepair, do not attempt to operate. If appliance is not working as it should, has been dropped, damaged, left outdoors, or dropped into water, return it to a service center.
- 5 Do not clean the unit, or unclog the hose until the Rainbow is switched off and the plug is removed from the wall outlet.
- 6 Do not connect to the receptacle of an incandescent light fixture, or use any extension cords.
- 7 Do not use the Rainbow to unplug drains. If sewer gas is drawn into the Rainbow it could cause an explosion.
- 8 No one should ever touch a metal sink, cold or hot water pipe with one hand while touching the metal parts of any electrical appliance, light fixture or switch with the other hand. One's body could complete an electrical circuit to the ground. Additionally, wet skin surfaces can greatly increase this hazard. Do not handle plug or appliance with wet hands.
- 9 (a) Do not put any objects into openings. Do not use with any openings blocked; Keep free of dust, lint, hair, and anything that may reduce air flow; (b) Keep hair, loose clothing, fingers, and all parts of the body away from openings and moving parts; (c) Use extra care when cleaning on stairs.
- 10 Do not pick up anything that is burning or smoking such as cigarettes, matches or hot ashes; Do not use to pick up flammable or combustible liquids such as gasoline or use in areas where they may be present.
- 11 This appliance is provided with double insulation. Use only identical replacement parts. See instructions for Servicing of Double-Insulated appliances.
- 12 Always follow these **IMPORTANT SAFEGUARDS**.
- 13 **CAUTION — ALWAYS REPLACE THE SEPARATOR IMMEDIATELY AFTER CLEANING. DO NOT OPERATE WITHOUT THE SEPARATOR.**

- 14 **WARNING** — To avoid risk of electrical shock, never use the electrified hose (supplied with the Power Nozzle) to pick up water or any other fluids. Use only the Rainbow hose for wet-pickup operations. Refer to page 14 for illustrations and descriptions of each hose.

**WARNING: TO AVOID ELECTRICAL SHOCK
DO NOT USE OUTDOORS.**

CAUTION: It is recommended that you not use the Rainbow to clean the fire place or the chimney flue, or any other oily or greasy compounds (such as soot) or ashes, ceramic dust, drywall, plaster dust or other powdery substances that are resistant to the wetting action of water. Do not use the Rainbow to pick up or in the vicinity of any volatile or toxic materials.

**USE THE RAINBOW ONLY AS DIRECTED IN
THIS OPERATION MANUAL!**

**SAVE THESE INSTRUCTIONS!
— FOR HOUSEHOLD USE ONLY —**

WET PICK-UP INSTRUCTIONS



When using the Rainbow for wet pick-up follow directions exactly:

1. Start with empty basin and never pick up more than two quarts without emptying. That is to say, NEVER let water level in basin get above center post. This will cause the Rainbow to vibrate or shake.
2. Do not use when your hands are wet, or with bare or wet feet.
3. Do not stand in water when using the Rainbow for wet pick-up. However, if in order to pick up water you find it necessary to stand on a wet (damp) floor, be absolutely certain you do not touch the metal parts of any electrical appliance, light fixture or switch.
4. Never use for wet pick-up outside, on the ground, in a basement, or in a room where a film of water can reach a ground.
5. Do not touch any metal parts of the Rainbow motor unit, such as the separator attaching nut, until you have first disconnected the electrical cord from the wall outlet.

WARNING: To avoid risk of electrical shock, never use the electrified hose (supplied with the Power Nozzle) to pick up water or any other fluids. Use only the Rainbow hose, supplied with the Rainbow, for wet-pickup operations. Refer to illustrations and descriptions of each hose on page 14.

PROPER CARE FOR LONG LIFE OF THE RAINBOW

SEPARATOR - Remove and clean the separator after each use. Remove separator (using a screwdriver — if necessary) clean inside and out with soap and water using the Rainbow Separator Brush, which is supplied. Dry and replace the separator. Tighten the nut finger-tight to hold the flat rim of the separator snug. Do not force the separator nut so it depresses the separator into the shaft onto which the nut is threaded.

CAUTION-ALWAYS REPLACE THE SEPARATOR IMMEDIATELY AFTER CLEANING.
DO NOT OPERATE WITHOUT THE SEPARATOR.

WATER - Do not clean too long with one filling of water. Check water during cleaning, and if water is too thick with lint and dirt, empty dirty water and put in clean water. The correct water level is the top of the post located in the center of the Rainbow® water basin.

NEVER FILL BASIN ABOVE POST.

BASIN - Remove Rainbow power unit from basin when not in operation. After each cleaning the basin should be emptied, washed out thoroughly and dried. Leave the Rainbow OFF basin while storing between each cleaning.

Neglecting part or all of the above instructions will cause unnecessary trouble and expense for service. Following these instructions should give you years of trouble-free, efficient service.

THE RAINBOW IS MANUFACTURED BY REXAIR AND SOLD TO ITS AUTHORIZED RAINBOW DISTRIBUTORS FOR RESALE SOLELY THROUGH IN-HOME DEMONSTRATIONS TO ULTIMATE USER-OWNERS. ANY OTHER SALE IS STRICTLY PROHIBITED.

OPERATION AND CARE

1 Fill water basin with cold tap water to the top of the post located in the center of the basin. This is the correct amount of water (2 quarts) for all cleaning operations performed by the Rainbow.

2 Set power unit on top of basin so air intake protrudes through side opening. **Be sure that entire rim of power unit is firmly seated in groove on top of basin.** Hook the two clamps to the rim of the water basin and snap up. Place on dolly.

3 Insert the long curved bottom wand into the floor and wall brush by matching grooves on tool with bumps on wand. Give tool half a turn to lock in place.

Reminder: The water in the basin must remain liquid to effectively trap dust and dirt. Therefore, **DO NOT** clean too long with one filling of water. **When water becomes thick with lint and dirt, empty water basin and refill.**

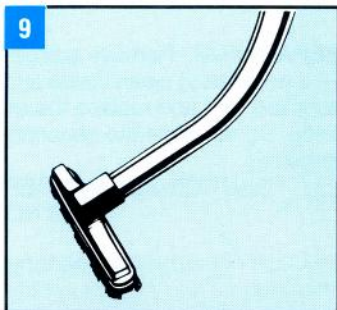
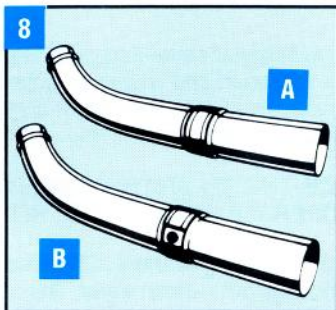
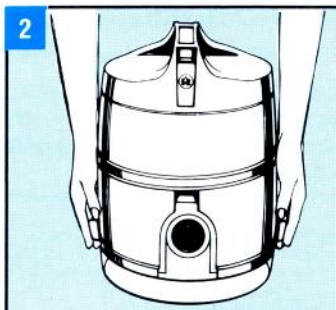
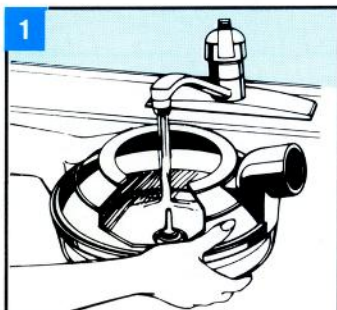

7 Connect electrical cord to outlet. Turn switch on top handle to the "ON" position. When unit is "OFF", remove from basin until ready to use.

8 A) Adjust airflow control sleeve on top of curved wand. Close opening with airflow control sleeve for full power. B) To reduce airflow, rotate airflow control sleeve so opening in curved wand is exposed. Adjust as needed for different cleaning jobs.

9 With the machine at the left and to the rear, hold the curved wand with the right hand at a comfortable angle. Grasp the hose with the left hand making a loop behind the back. Slowly guide the tool back and forth in smooth and easy strokes. Let the tool and the Rainbow do the work.

Warning: Because of the danger of shock, any electrical appliance should be used only as directed. There should be no unapproved use of any electrical product. Electrical leakage and shorts can occur wherever there is electricity. With any electrical appliance, if the user is not grounded there is generally no serious hazard. But if the user is standing on the ground, in a basement, or in a room where a film of water can reach a ground, severe shock could result. Therefore, use the Rainbow only as directed in this operation manual. Refer to the Important Safeguards Section on page 6. This, of course, is true of any use of electricity with electrical fixtures or appliances that can develop shorts.

4 Connect the straight wand and handle (short curved wand) and insert into the bottom wand with tool on end. **Should the wands come apart while in use, tap lightly with curved wand, between slots at end of the bottom wand and/or straight wand until a snug fit is obtained.** Should wands wedge tightly together, hold parallel to the rug or carpet and drop them. The vibration will cause them to loosen. Repeat the process if necessary. If the wands are properly adjusted for snugness they will not wedge together.

5 Push soft end of Rainbow hose over raised ridge on handle until it "SNAPS" in place.

6 Insert metal end of Rainbow hose into the air intake until it clicks. To remove, press spot on coupling marked "PRESS" and pull Rainbow hose from machine.

SERVICING

SERVICING OF DOUBLE-INSULATED APPLIANCE — In a double-insulated appliance, two systems of insulation are provided instead of grounding. No grounding means is provided on a double-insulated appliance, nor should a means for grounding be added to the appliance. Servicing a double-insulated appliance requires extreme care and knowledge of the system, and should be done only by qualified service personnel. Replacement parts for a double-insulated appliance must be identical to the parts they replace. A double-insulated appliance is marked with the words "DOUBLE-INSULATION" or "DOUBLE-INSULATED." The Symbol (square within a square) may also be marked on the appliance.

Any servicing other than cleaning should be performed by an authorized service representative.

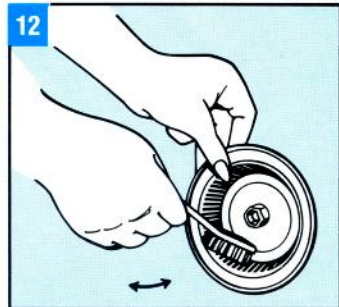
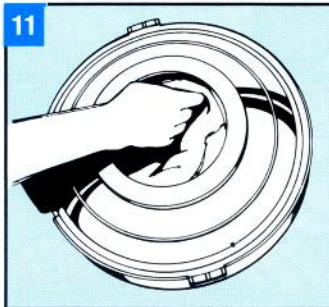
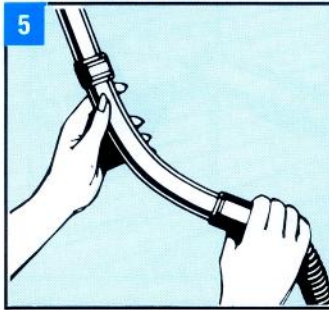
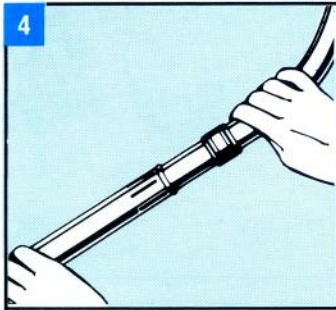

10 To empty water basin: 1) re-release the two clamps. 2) Remove power unit. 3) Pick up water basin by the curved air intake and pour dirty water from the opposite side. 4) The heavier particles of foreign matter such as soaked lint, etc. will settle to the bottom of the basin when pouring out the dirty water. 5) Next, it is recommended that you simply remove the wet, foreign matter, such as soaked lint, etc., by placing it into a plastic disposal bag or waste container.

11 Wash out water basin, rinse and dry thoroughly. **Leave Rainbow power unit OFF basin until the next time it is used.**

12 **SEPARATOR** - Remove and clean the separator after each use. Remove separator (using a screwdriver—if necessary) clean inside and out with soap and water which is supplied. Dry and replace the separator. Tighten the nut fingertight to hold the flat rim of the separator snug. Do not force the separator nut so it depresses the separator into the shaft onto which the nut is threaded. **CAUTION-ALWAYS REPLACE THE SEPARATOR IMMEDIATELY AFTER CLEANING. DO NOT OPERATE WITHOUT THE SEPARATOR.**

DUSTING BRUSH AND UPHOLSTERY TOOL

1 2 The Rainbow® dusting brush is a wonderful tool to be used for those special cleaning jobs. Good for lamps, lamp shades, venetian blinds, books, ornaments and the like. Just attach to the curved wand and move lightly over the surface to be dusted.

3 Use it for cleaning dogs and cats. Dust, dirt and loose hair are easily removed by the Rainbow's silent airflow. Frequent grooming cuts down on the need for baths and your pets will enjoy it too.

Reminder: Don't forget - for use on delicate objects, reduce airflow by opening the Airflow Control Sleeve. To avoid abrasions to delicate surfaces (such as shades and/or highly polished surfaces), remember to remove and clean bristles in warm soapy water. Let dry before replacing.

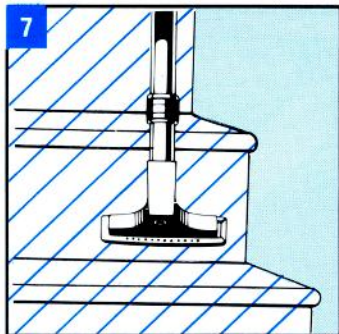
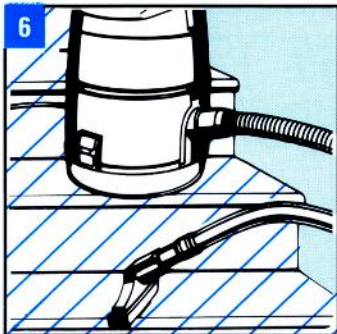
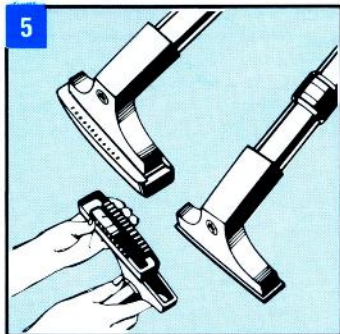
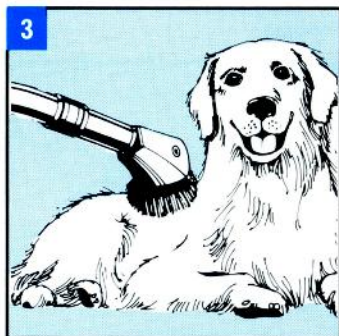
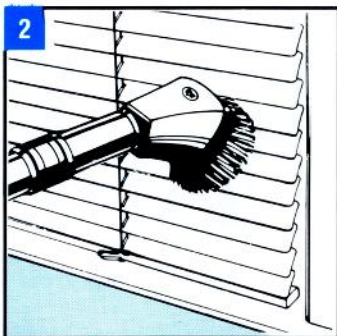
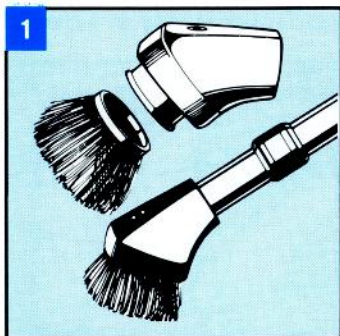

5 To clean upholstered furniture use the Rainbow® upholstery tool. The upholstery tool may be used alone or with the Jet Brush (see above illustration). Attach upholstery tool to curved wand. A slight twist as they are pushed together will make them hold securely. Use with full airflow. To remove dirt, move tool over areas to be cleaned with slow, even strokes. To clean Jet Brush, whisk with open end of hose or slide upholstery tool out of the slots on top of the brush and wash in warm soapy water.

6 To clean stairs, remove Rainbow® from dolly. Allow the Rainbow® to rest solidly on stair above the one being cleaned. Move the Rainbow® up one step at a time and continue cleaning.

7 To clean rug riser, turn tool one-half turn and use as illustrated.

4 Reduce airflow and gently brush over plants to remove dust and dirt which blocks light and hides the natural sheen of the foliage.

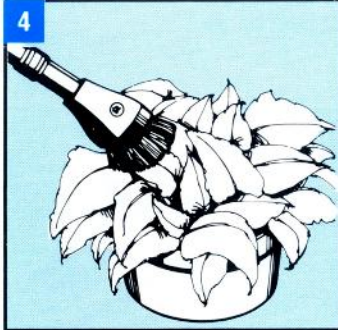

Try your Rainbrow® dusting brush on • lighting fixtures • lamp shades • stereo and VCR equipment • picture frames • pianos • hats • heat and cold air vents • inside kitchen and bathroom drawers • screens.

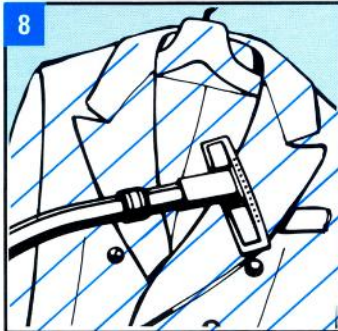

8 Clean the surface of suits, wool and fur coats, with upholstery tool with the jet brush. For delicate fabrics, reduce airflow.

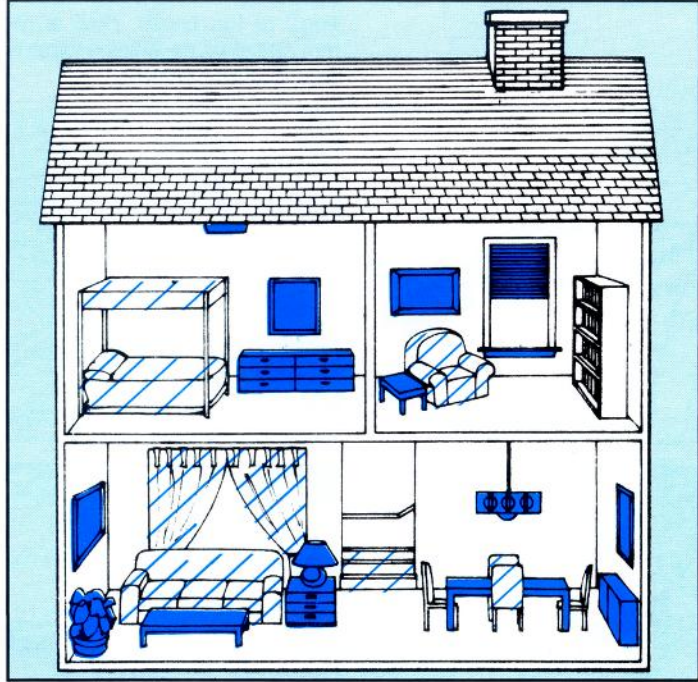

Use the upholstery tool with jet brush on: • sofas • chairs • mattresses • pillows • blankets • drapes and curtains • closet shelves • Help prevent moths by cleaning wool coats and sweaters before storing.

THE RAINBOW IS MANUFACTURED BY REXAIR AND SOLD TO ITS AUTHORIZED RAINBOW DISTRIBUTORS FOR RESALE SOLELY THROUGH IN-HOME DEMONSTRATIONS TO ULTIMATE USER-OWNERS. ANY OTHER SALE IS STRICTLY PROHIBITED.

ADDITIONAL USES FOR THE RAINBOW

1 To clean hardwood floors, linoleum, tile, or walls, use the combination floor and wall brush. Attach the brush to the metal wand. The brush locks into position and will not fall off. Use full airflow when cleaning floors.

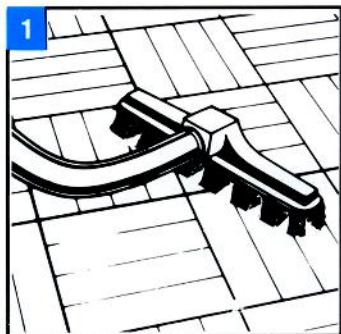

1A) When cleaning walls, best results are obtained when only the top edge of the brush is allowed to touch the wall and cleaning is done with a downward stroke. With a slight space between the wall and the bottom edge of the brush, dust is removed before the bristles touch it, thus avoiding streaks.

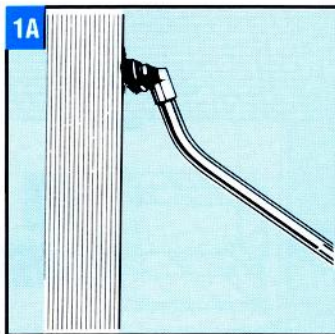

1B) To clean the floor and wall brush, just whisk it clean with the open end of the hose, or remove furniture guard and snap off brush from holder. Wash brush in warm soapy water and reassemble when dry. Beaded edge of guard should be up.

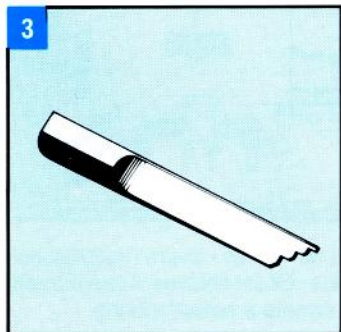
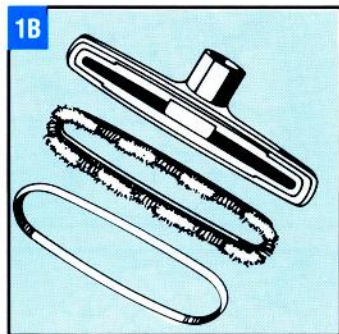

3 The RainBOW® crevice tool is designed to achieve maximum airflow and cleaning power. Attach to curved wand and use full airflow, with airflow control sleeve closed.

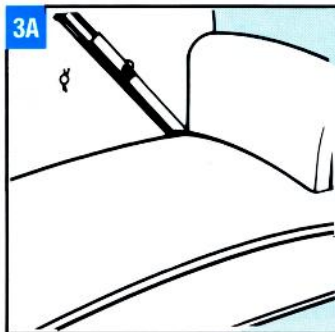

3A) Use crevice tool to clean deep down between furniture and automobile cushions.

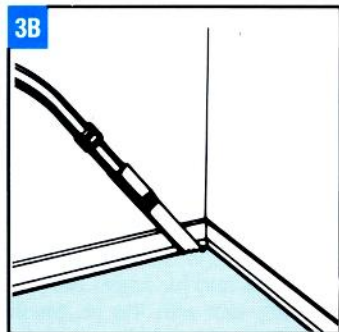

3B) The crevice tool reaches those low areas along baseboards, under radiators, and between radiator sections.

THE RAINBOW IS MANUFACTURED BY REXAIR AND SOLD TO ITS AUTHORIZED RAINBOW DISTRIBUTORS FOR RESALE SOLELY THROUGH IN-HOME DEMONSTRATIONS TO ULTIMATE USER-OWNERS. ANY OTHER SALE IS STRICTLY PROHIBITED.

CLEANER



2 Attachment Caddy

The Attachment Caddy snaps into place on your Rainbow and provides convenient storage for your Rainbow attachments and power cord.

2A) The Attachment Caddy features a convenient rotating arm which allows easy removal of the Rainbow power cord. Simply rotate the arm down to release the power cord from the caddy. For installation, make sure all three locking legs of caddy lock under the lip of the cap. Line up notch in caddy with rib on cap to prevent caddy from turning.

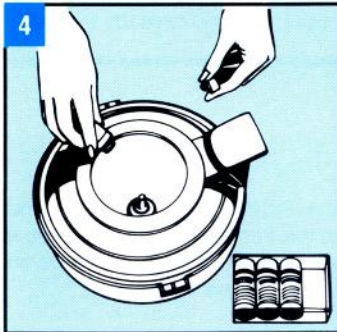
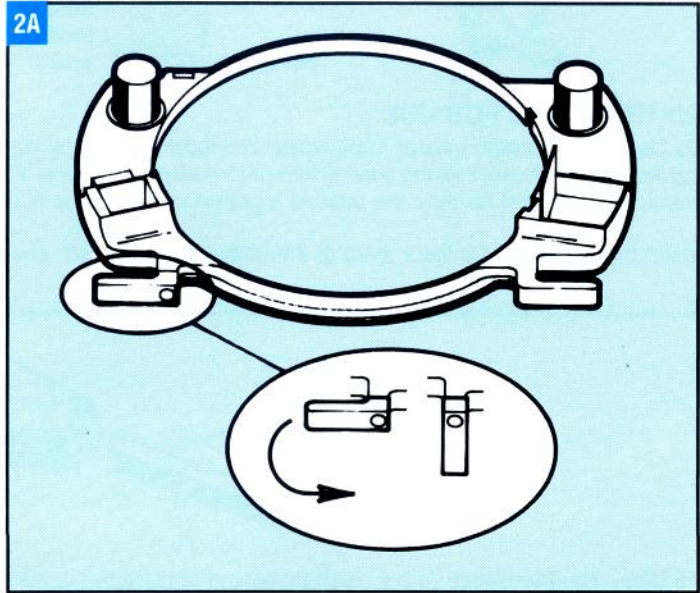
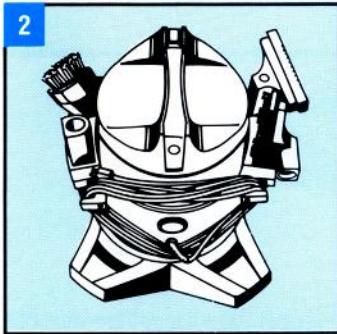

4 TO AROMATIZE... Put a few drops of any Rainbow® fragrance such as Violet, Apple Blossom, Siberian Pine, Gardenia, Spice, Lemon, or Orange in the Rainbow water basin. Assemble the Rainbow on the basin and turn on switch. In a matter of minutes a pleasant fragrance will permeate the room.

Caution: Use only genuine Rainbow products. The use of non-approved products may cause damage to your Rainbow.

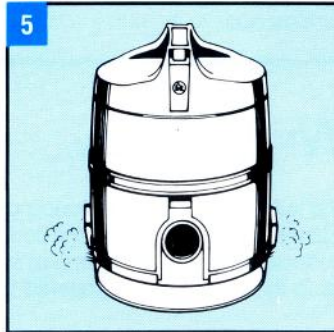

5 TO DEODORIZE... Add two capfuls of Rainbow® Deodorant Air Freshener to the water in the basin, turn machine on. The 360 degree peripheral exhaust quickly refreshes the air in the entire area, alleviates objectionable household odors.

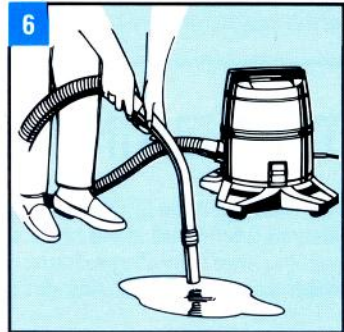

6 TO USE YOUR RAINBOW FOR WET PICK-UP... Refer to wet pick-up instructions on page 7. Follow these instructions carefully and **NEVER LET WATER LEVEL GET HIGHER THAN CENTER POST IN WATER BASIN. ONLY USE THE RAINBOW HOSE FOR WET PICK-UP.**

INFLATOR TOOL

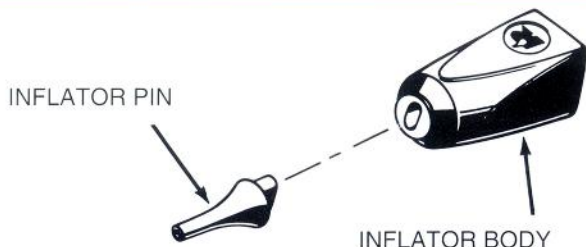

The **Rainbow** Inflator Tool is ideal for inflating beach balls, inflatable toys, and air mattresses. The Refrigerator Coil Cleaner Extension is ideal for cleaning hard-to-reach areas.

INSTRUCTIONS FOR USE:

To Use The **Rainbow** Inflator Tool, attach **Rainbow** hose to exhaust opening on the **Rainbow**. Attach curved wand to hose, making sure airflow control sleeve on wand is closed. Attach inflator tool to curved wand. A slight twist as they are pushed together will make the fit secure.

Insert the pin into the inflator stem of the object to be inflated, and switch on the **Rainbow**.



To Clean Hard-to-Reach Areas, such as behind or underneath the refrigerator, use the refrigerator coil cleaner extension. Remove the inflator pin from the end of the inflator body, and replace with the extension. Push all the way in for a snug fit. Attach **Rainbow** hose to air intake on the **Rainbow**, and you're ready to clean.

THE RAINBOW HOSE

The **Rainbow** hose is light in weight and truly flexible. The soft coupling at the end is easy on the hands, and assures a firm hold of the hose at all times. To clean: insert hard coupling marked "PRESS" into exhaust opening after removing exhaust cap. Place the soft coupling end of the hose into the air intake. Switch on motor and jiggle hose. Any dirt stuck in the hose will be drowned in the **Rainbow's** water bath.



The **Rainbow**® Hose

- Use for wet & dry pickup.
- Supplied with the **Rainbow**.



The Electrified Hose

- Use only for dry pickup. To avoid risk of electrical shock, never use to pick up water or any other fluids.
- Supplied with the Power Nozzle. For use with Power Nozzle and RainbowMate.

SPECIAL EQUIPMENT & SUPPLIES



1 4-Quart Basin

The Rainbow® 4-Quart Basin is available for those "bigger" cleaning jobs. The larger water basin fits the Rainbow dolly and doubles the cleaning capacity of the Rainbow. It's ideal for larger homes and "over-sized" cleaning jobs.

2 Floor Squeegee

The new Rainbow® Floor Squeegee allows you to deep-clean your linoleum and tile floors without getting your hands wet. Use with Rainbow® Floor Cleaner Concentrate to clean your floors with a minimum of effort.

3 Rainbow® Fragrance Pack

Bring the sweet and refreshing smell of a spring garden into your home with the Rainbow Fragrance Pack. Apple Blossom, Violet, Gardenia and Siberian Pine Fragrance will fill your home with the pleasant aroma of the great outdoors. Also available: Four packs of Spice, Lemon, Orange, and fragrances listed above.

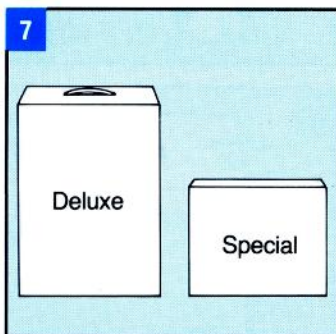
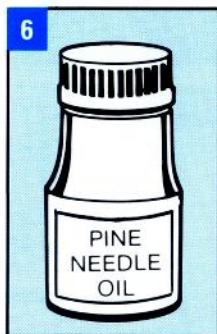
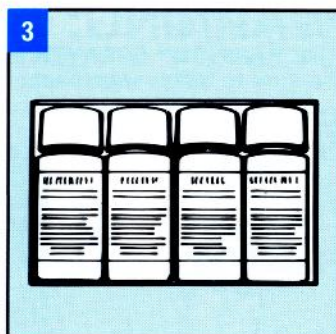
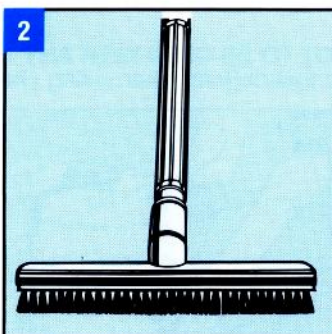
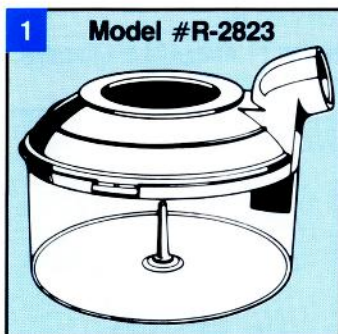

4 Rainbow® Deodorizer-Air Freshener

Two capfuls of Rainbow Deodorizer-Air Freshener added to the water in the Rainbow Water Basin alleviates objectionable household odors such as fish, tobacco, cabbage, paint, etc. One quart.

5 Rainbow® Floor Cleaner Concentrate

Rainbow Floor Cleaner Concentrate is ideal for thoroughly cleaning linoleum or tile floors. Just spread on Floor Cleaner Concentrate in recommended solution and let it do the work. One quart.

6 Rainbow® Pine Needle Oil

Rainbow Pine Needle Oil adds a delightful Pine Needle freshness to the home. Simply break only one capsule into the water in the Rainbow Water Basin and bring the fragrance of pine indoors. 100 capsules.

7 Rainbow® Accessory Packs

A) Deluxe Accessory Pack includes the following items: 1) 4-Quart Basin, 2) Floor Squeegee, 3) Rainbow Sprayer, 4) Fragrance Pack, 5) Aerofresh Bag, 6) Deodorizer-Air Freshener and, 7) Floor Cleaner Concentrate.

B) Special Accessory Pack includes: 3) Rainbow Sprayer, 4) Fragrance Pack, 5) Aerofresh Bag and, 6) Deodorizer-Air Freshener.

SPECIAL EQUIPMENT & SUPPLIES

8 Sprayer Assembly

The **Rainbow** Sprayer Assembly (A) attaches to your **Rainbow** wands and is used to spray insecticides, moth proofing solutions, etc. It can also be used with liquid fertilizers or plain water on your houseplants. To use the Sprayer, simply fit it onto your **Rainbow** curved wand and (B) connect the hose to the air exhaust on your **Rainbow**.

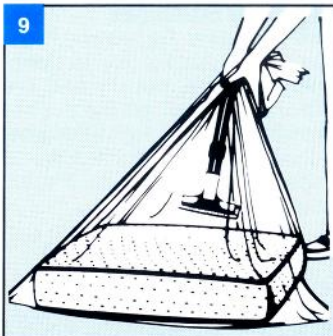

9 Aerofresh Bag

This handy plastic bag is sized to fit even your largest cushions and pillows. Place cushion in Aerofresh bag. With the upholstery tool attached to the end of the wand, hold bag tightly around wand (see diagram) and remove stale, dusty air from the cushion. Without letting go of bag at wand, quickly remove exhaust cap and attach hose to air exhaust opening on **Rainbow** to "refluff" your cushion with clean, water-washed air.

WARNING:

THE RAINBOW SPRAYER IS NOT TO BE USED WITH ANY TYPE OF FLAMMABLE LIQUIDS. Be sure to follow manufacturer's instructions when using chemical solutions.

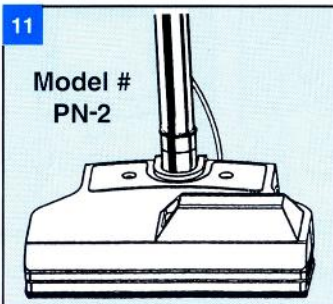
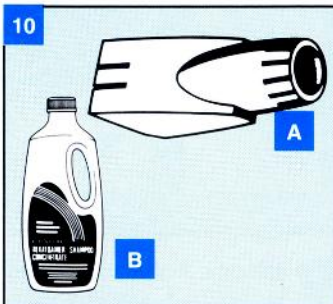
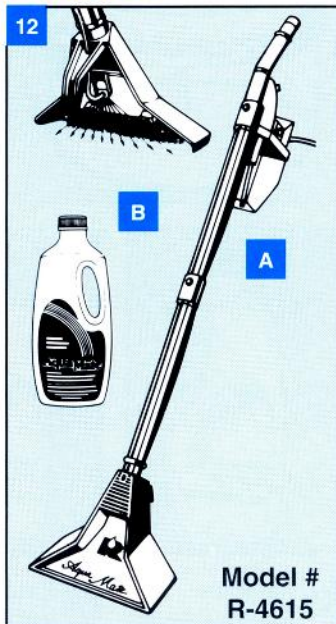
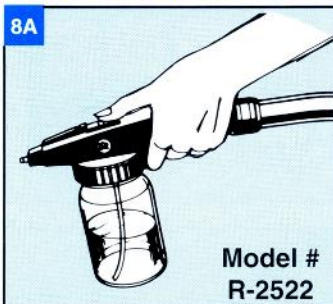

10 Rexafoamer

A) The **Rainbow** Rexafoamer makes "dry" suds from liquid shampoos. Your rugs and carpets can be shampooed inexpensively, yet professionally, right in the home.

B) Rexafoamer Shampoo Concentrate quickly removes unsightly traffic film from rugs and carpets. No hard scrubbing required. Cleanses thoroughly, dries quickly. One quart.

11 Rainbow Power Nozzle

The Power Nozzle adds motorized brush action to the already superlative cleaning efficiency of the **Rainbow**. The rapidly revolving brush loosens lint, threads, hair and dirt for easy pickup into the **Rainbow** water basin. It connects quickly and conveniently to the **Rainbow** and makes most deep nap, pile and shag carpets easier to groom and clean. The fully motorized Power Nozzle is easy to use, sturdy and lightweight.

Warning: Severe electrical shock could occur if used outside or on wet surfaces.

12 A) AquaMate®

The AquaMate carpet cleaning extraction unit allows you to achieve professional results without the professional price tag.

B) AquaMate Carpet Cleaning Formula combines cleaner, deodorizer, protector, and conditioner for ease of operation and superior cleaning results. One quart.

OPERATIONS CHECKLIST



This **Rainbow** appliance was thoroughly tested and inspected at the factory. It was in good operating condition when shipped. If a minor problem develops, the following trouble shooting procedures may help identify and correct the problem with a minimum inconvenience.

PROBLEM	POSSIBLE CAUSE	POSSIBLE SOLUTION
A. Machine Won't Run	1. Not connected at wall outlet 2. No power to wall outlet 3. Defective cord, switch, or machine	1. Insert plug firmly into wall outlet or try another outlet 2. Check fuse or breaker and replace if bad 3. Call your Rainbow Distributor or Rainbow Service Center
B. Loss of Air Flow	1. Machine not correctly positioned on waterpan 2. Obstructed hose 3. Obstructed wand 4. Obstructed attachment utensil, or Power Nozzle 5. Clogged or dirty separator	1. Insure machine is correctly seated and latched onto waterpan 2. Remove obstruction 3. Remove obstruction 4. Remove obstruction 5. Turn off and unplug machine Remove separator and clean
C. Discharges Water or Water Droplets	1. Dirty or clogged separator 2. Separator not correctly seated	1. Clean separator 2. Clean area under separator and insure separator seats against spider shaped part correctly
D. Discharges Dust	1. Dirty or clogged separator 2. Separator not correctly seated 3. Low level of water in waterpan 4. Excessively dirty water in waterpan	1. Clean separator 2. Clean area under separator and insure separator seats against spider shaped part correctly 3. Fill waterpan to correct level 4. Replace with clean water
E. Heavy Foaming of Water in Waterpan	1. Soapy contaminant in water 2. High level of water in waterpan	1. Replace with clean water 2. Fill waterpan to correct level
F. Musty Odor	1. Waterpan not cleaned or dumped after use 2. Separator not cleaned after use 3. Machine stored on waterpan	1. Clean waterpan and use D & A when cleaning 2. Clean separator 3. Do not store machine on waterpan, Use D & A when cleaning
G. Machine Running, Hot or Burnt Odor	1. Plugged hose, wand, attachment, or Power Nozzle 2. Machine not seated on waterpan correctly 3. Separator not correctly seated	1. Check for clogged area and remove obstruction 2. Insure machine is correctly seated and latched onto waterpan 3. Insure separator is correctly seated
H. Different Tone, Noise or Vibration	1. Dirty or clogged separator 2. Separator not correctly seated 3. Water level above center post in waterpan	1. Clean separator 2. Insure separator is correctly seated 3. Empty and refill to correct level

NOTE: If the above solutions do not prove successful, call your Authorized **Rainbow** Distributor.

